



Werkzeuge und Geräte

Chance Stuckateurberuf im Ausbildungszentrum für Stuckateure

Berufliche Qualifizierung für eine Ausbildung oder Arbeit im Stuckateurberuf
Berufsförderungs-GmbH
Ausbildungszentrum für Stuckateure
Fockentalweg 8
71229 Leonberg
Telefon: 071 52 / 2 33 07
www.ueba-stuckateure.de

Chance Stuckateurberuf



Gefördert als JOBSTARTER plus-Projekt aus Mitteln des Bundesministeriums für Bildung und Forschung und dem Europäischen Sozialfonds der Europäischen Union.



Chance Stuckateurberuf Werkzeuge und Geräte

- Für Verputzarbeiten -

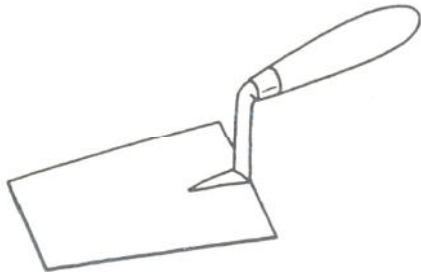

Putzkelle

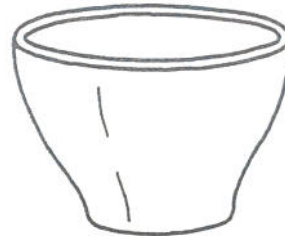

Gummibecher

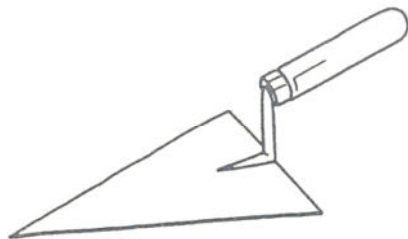

Spitzkelle

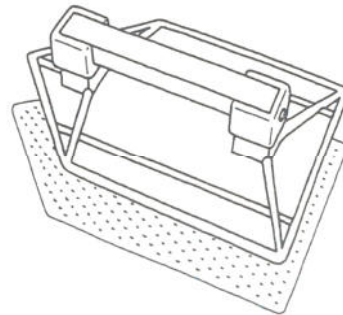

Reibscheibe mit Kunststoff

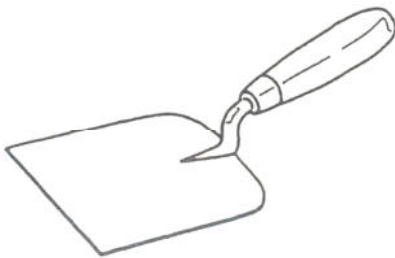

Spachtel, abgekröpft

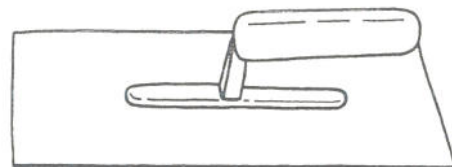

Glättekelle

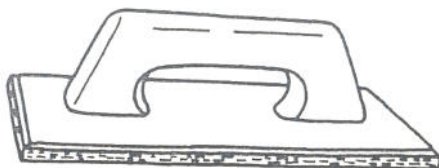

Reibscheibe mit Filz

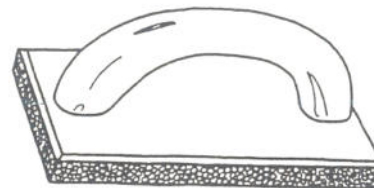

Reibscheibe mit Schaumgummi



- Für Verputzarbeiten -

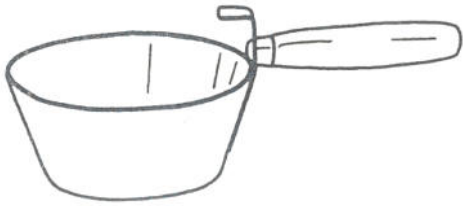

Gipserpfännchen



Traufel

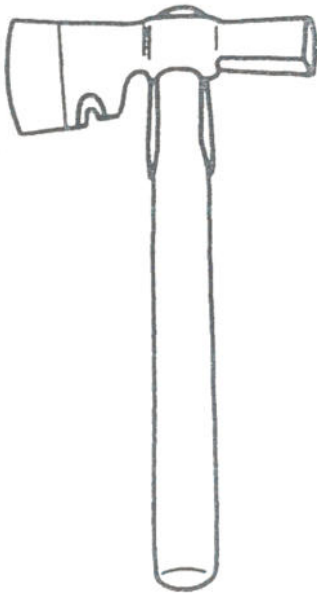

Gipserbeil

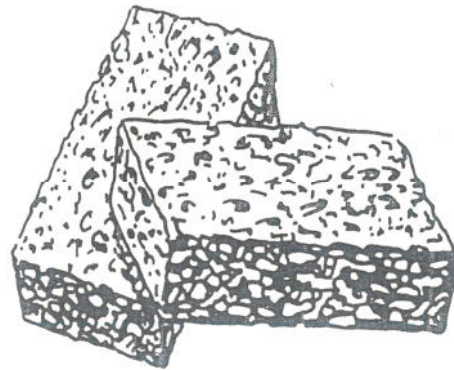

Schwamm

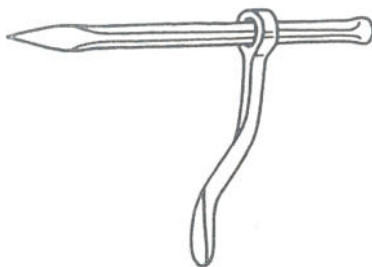

Mauerhaken

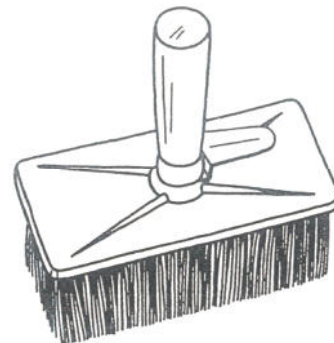

Deckenbürste

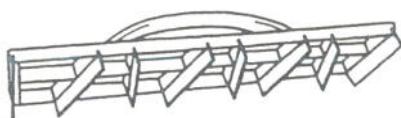

Gitter-Rabot

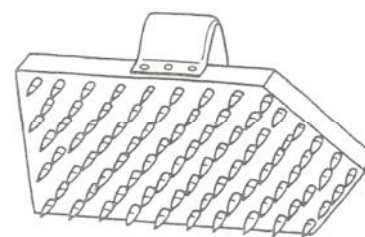

Edelputzkratzer



- Für den Trockenbau -

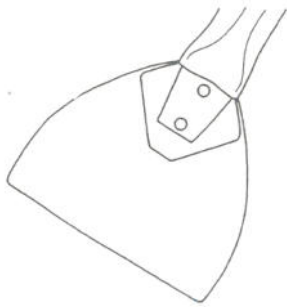

Rohrspachtel

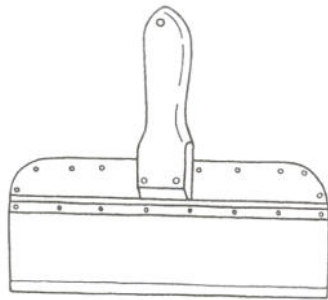

Breitspachtel

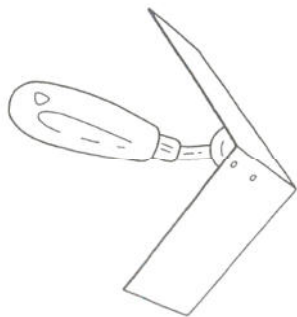

Innen-Eckspachtel

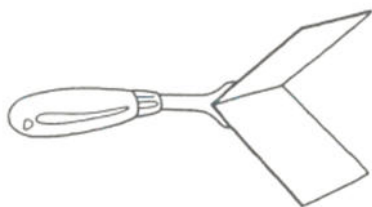

Außen-Eckspachtel

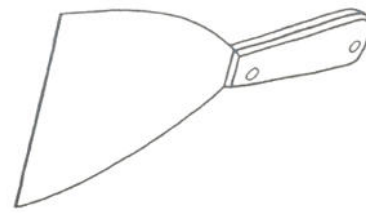

Hammergriffspachtel

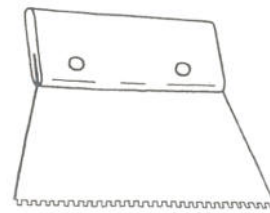

Gezahnte Spachtel

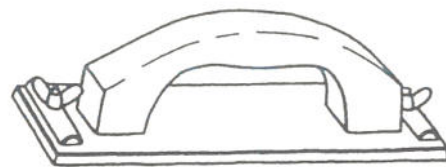

Handschleifer

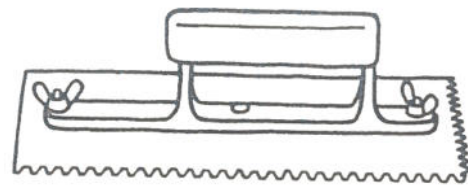

Gezahnte Kelle

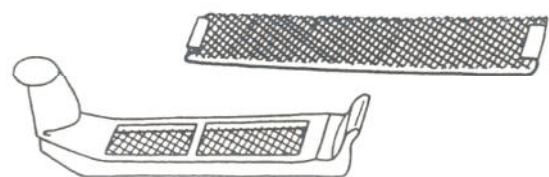

Surformobel mit Ersatzblatt



- Für den Trockenbau -

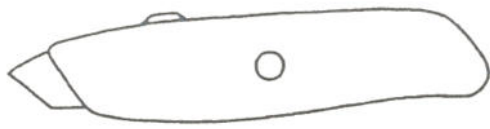

Klingmesser

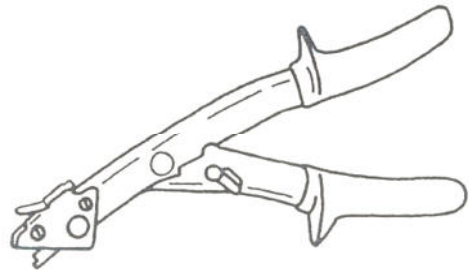

Blechknapper



Plattenmesser

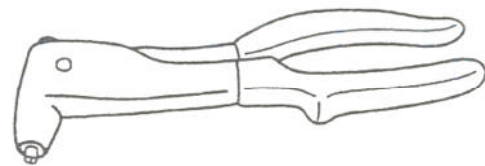

Blindnietzange

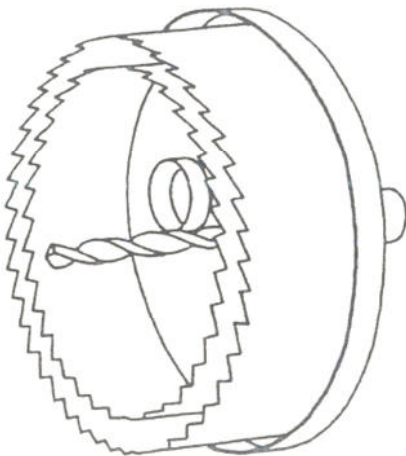

Lochschneider

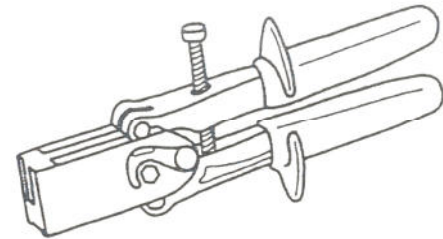

Dübelzange

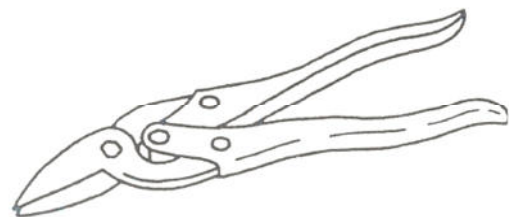

Blechscher

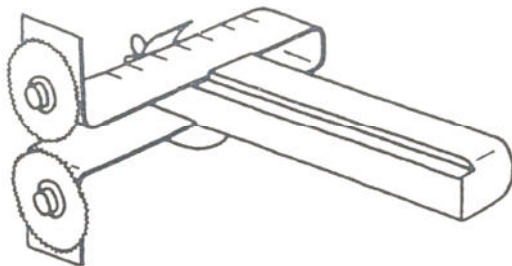

Plattenschneider

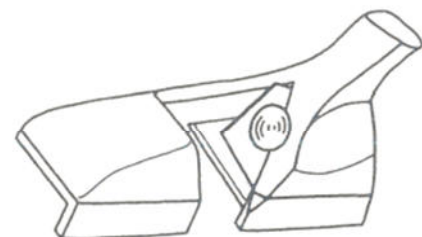

Kantenhobel



- Für den Stuckateur -



Fuchsschwanz, Feinzahnung



Kombinationszange (Flachzange)

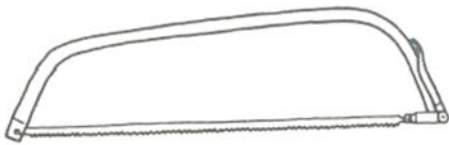

Stahlrohrbügelsäge

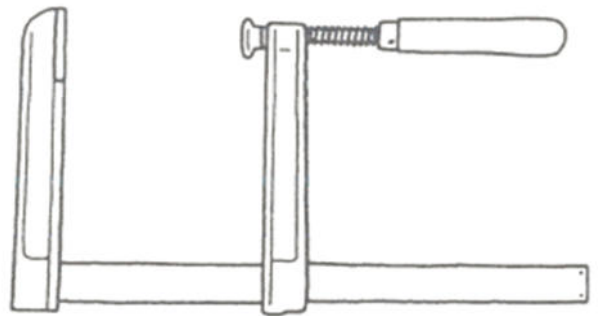

Schraubzange

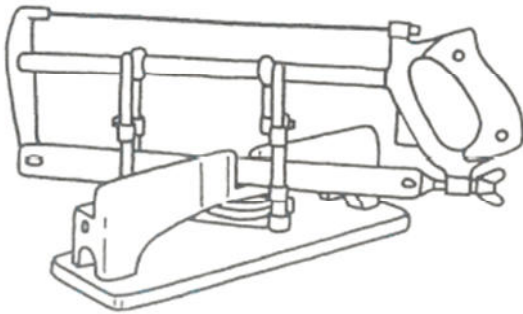

Gehrungssäge



Stichsäge

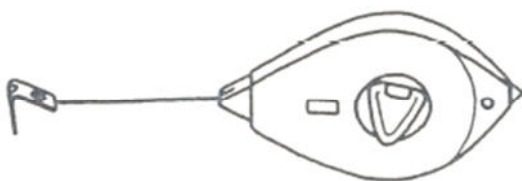

Schlagschnur

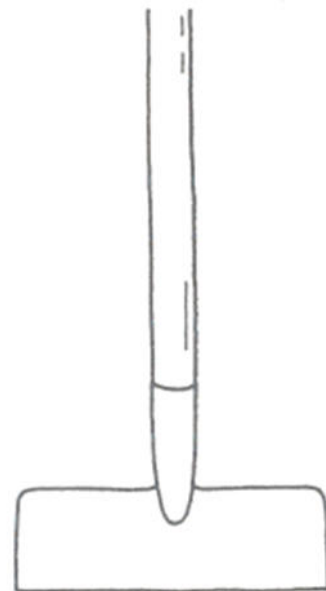

Gerüstschaber



- Für den Stuckateur -

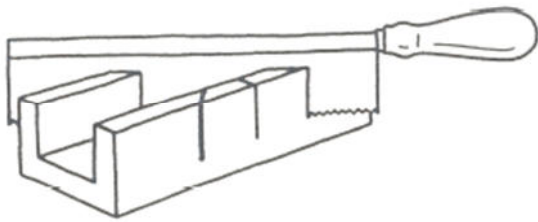

Gehrungskasten

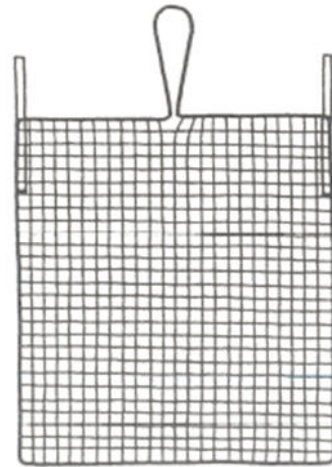

Abstreifgitter

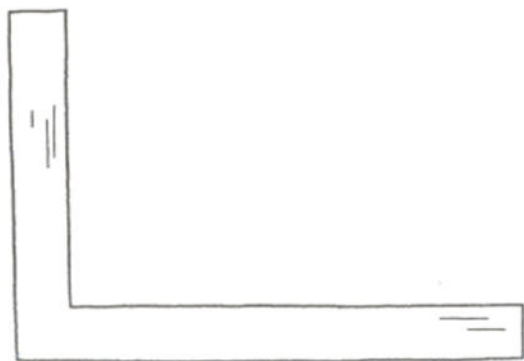

Eisenwinkel

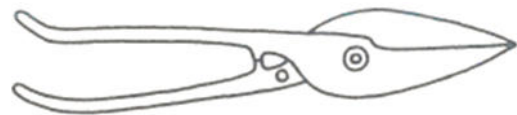

Bleischere

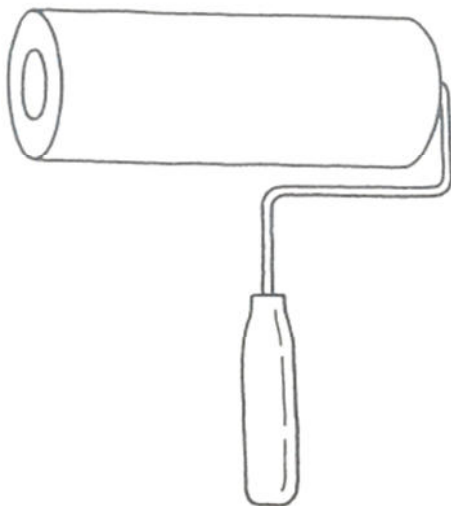

Roller aus Lammfell oder
Schwammgummi



Rabitzzange

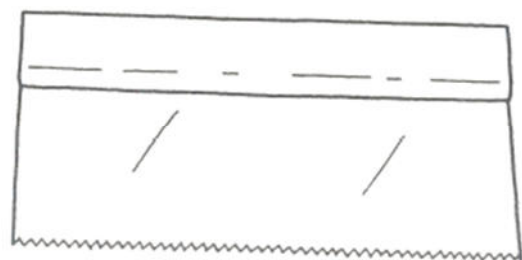

Gezahnte Flächenspachtel



- Für den Stuckateur -



Heizkörperpinsel

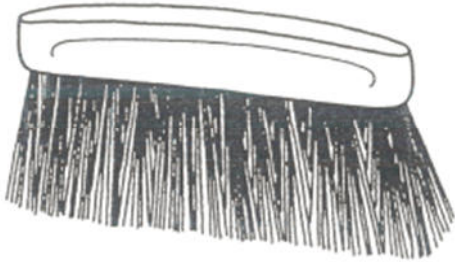

Staubbürste

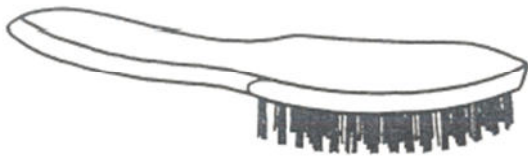

Stahldrahtbürste



Reisbürste

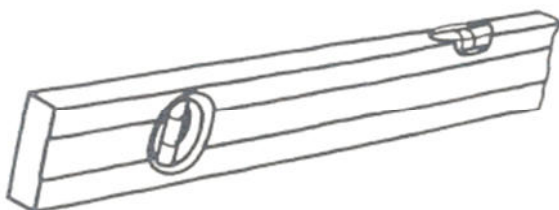

Wasserwaage



Senkblei, Lot



Richtschnur

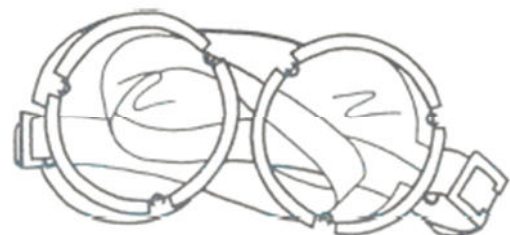

SUVA-Schutzbrille
